

# Marine Fenders

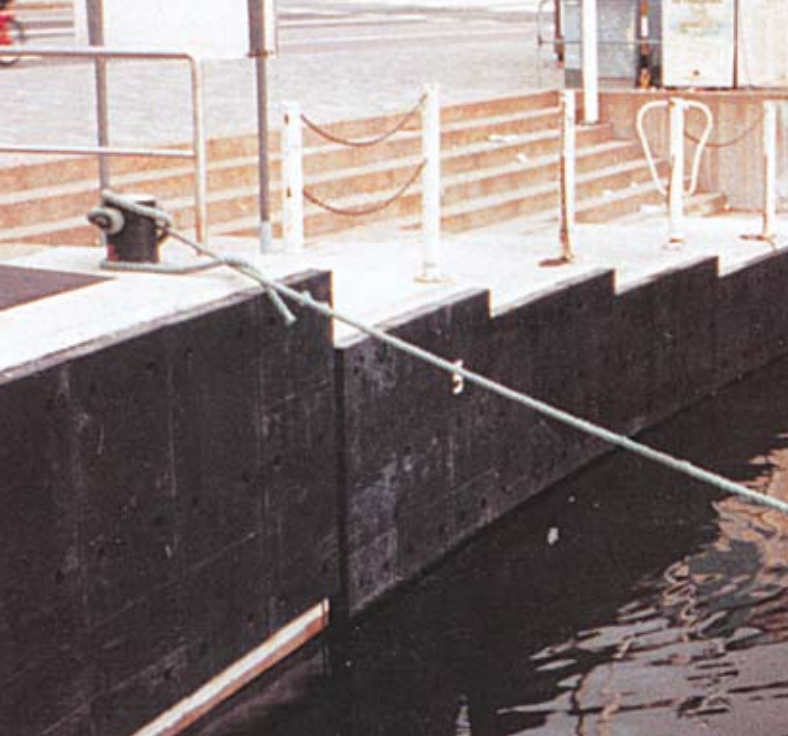

**TRELLEBORG**  
ENGINEERED SYSTEMS AUSTRALIA

# Marina Fendering

Colours available: White / Grey / Black  
(All dimensions in mm. Commercial Tolerances apply.)

## Dinghy Gunwale Fender

**QR S15**

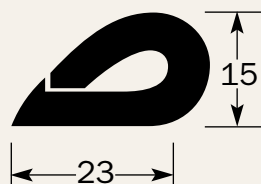

**QR S22**

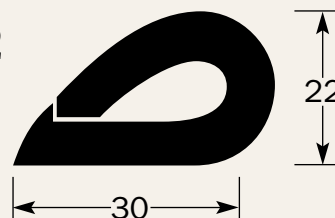

**QR S35**

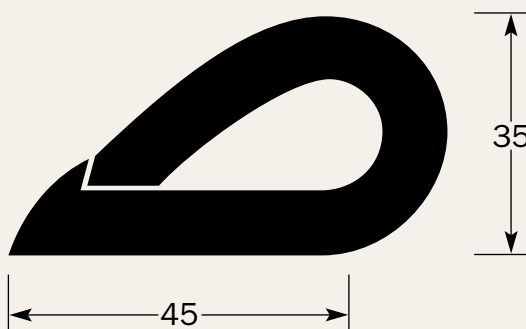

**QR S40**

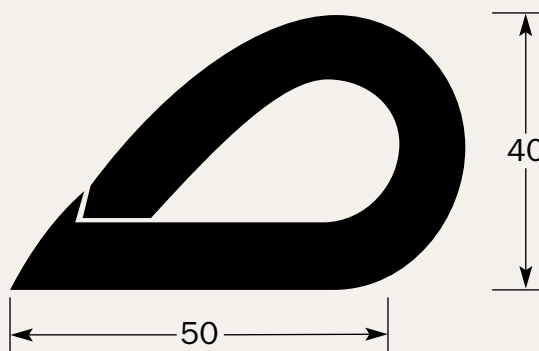

# Marina Fendering

PROFILES NOT TO SCALE

Colours available: White / Grey / Black  
(All dimensions in mm. Commercial Tolerances apply.)

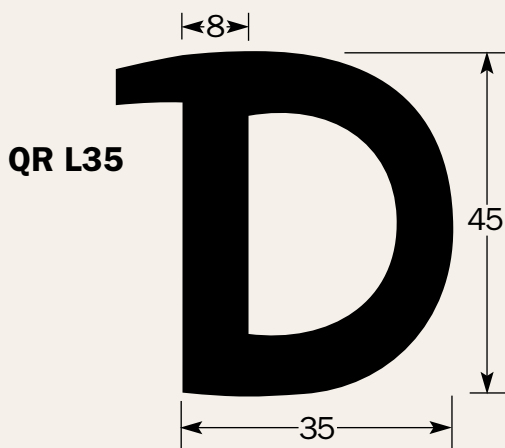
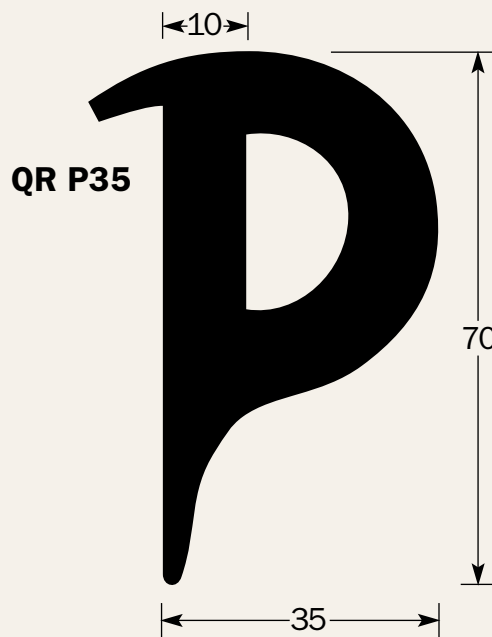
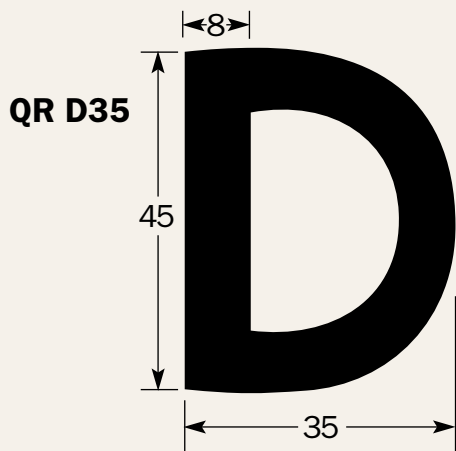
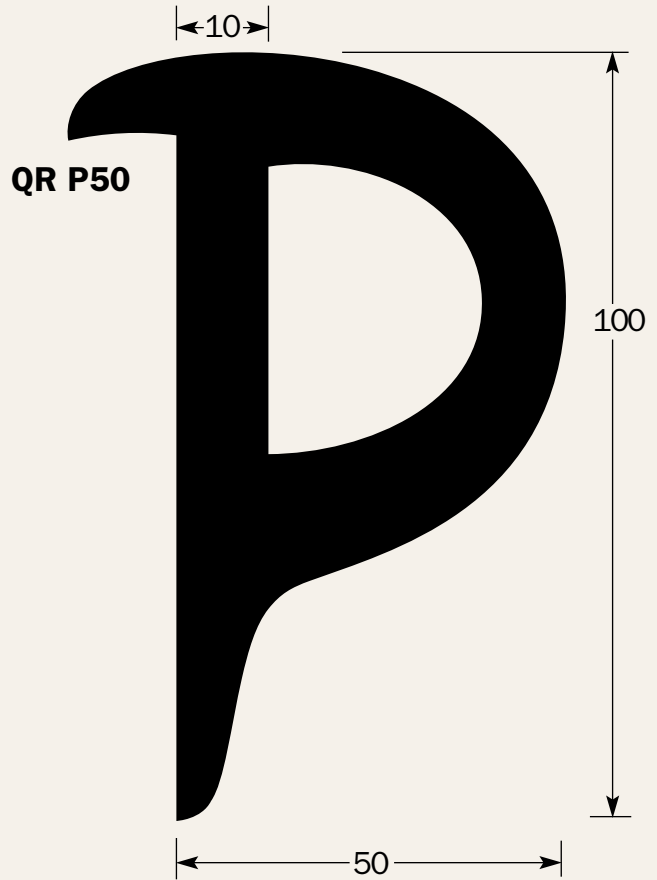
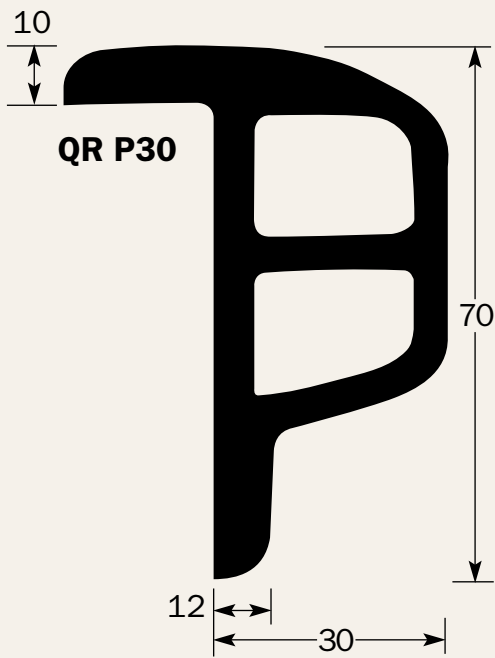

PROFILES NOT  
TO SCALE

# Marina Fendering

Colours available: White / Grey / Black  
(All dimensions in mm. Commercial Tolerances apply.)

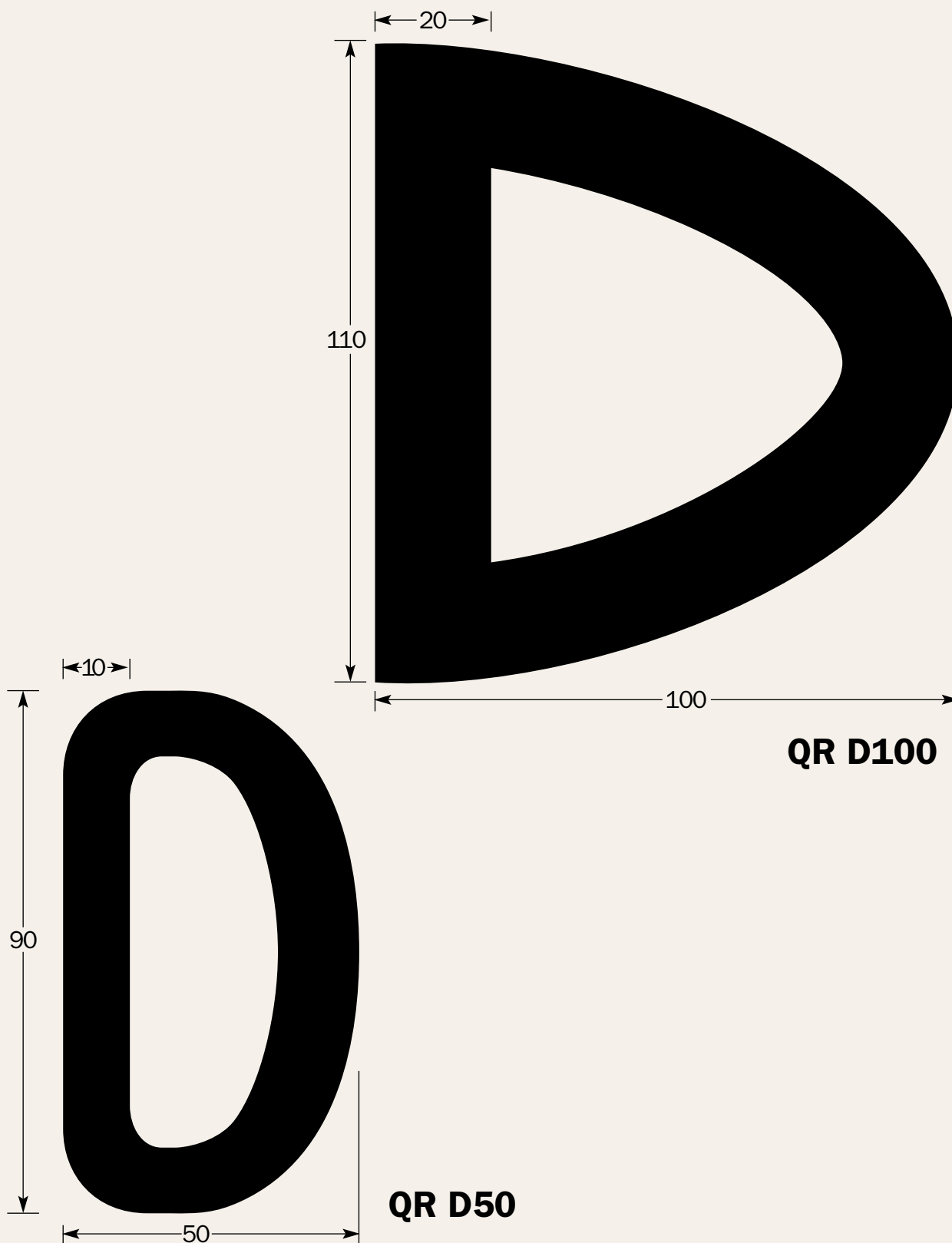

# Marina Fendering

PROFILES NOT TO SCALE

Colours available: White / Grey / Black  
(All dimensions in mm. Commercial Tolerances apply.)

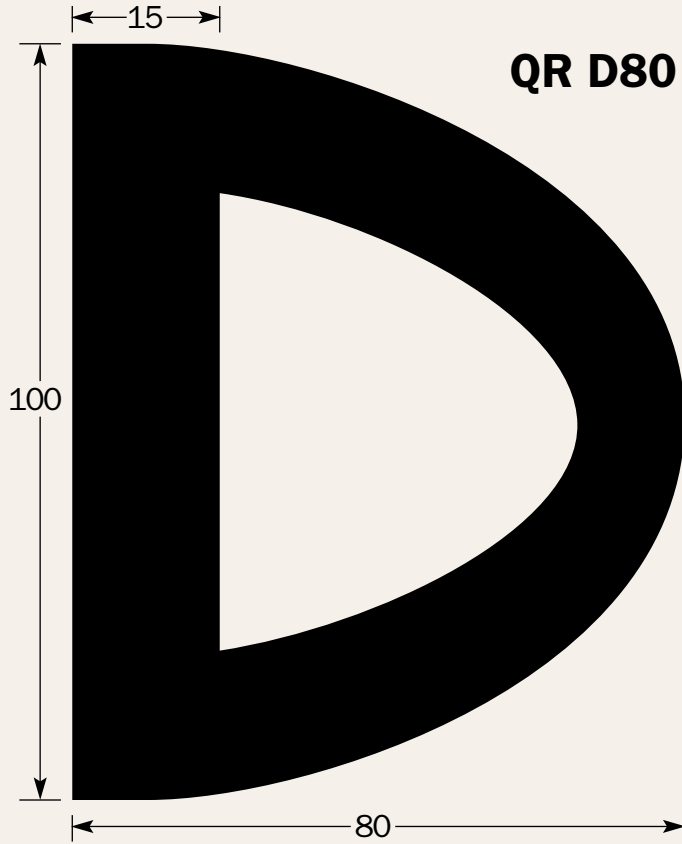

QR D65



QR L65

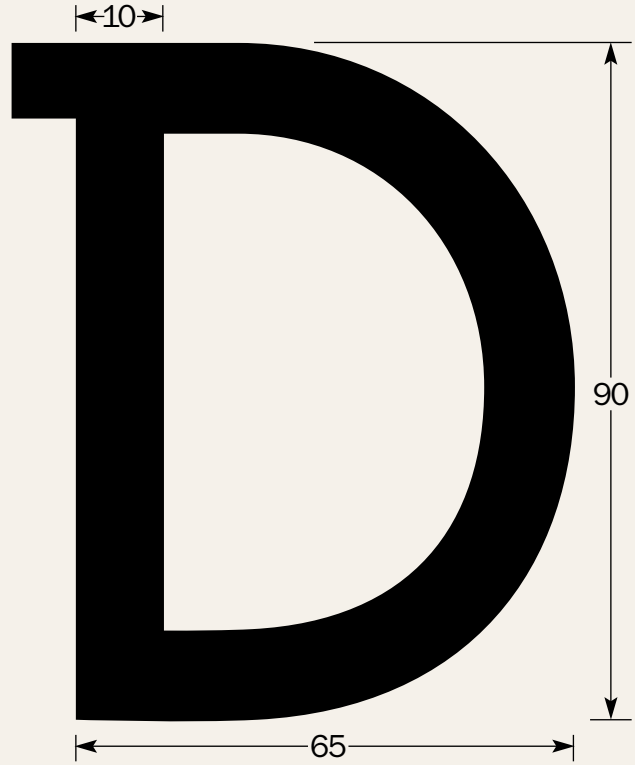

PROFILES NOT  
TO SCALE

# Marina Fendering

Colours available: White / Grey / Black  
(All dimensions in mm. Commercial Tolerances apply.)

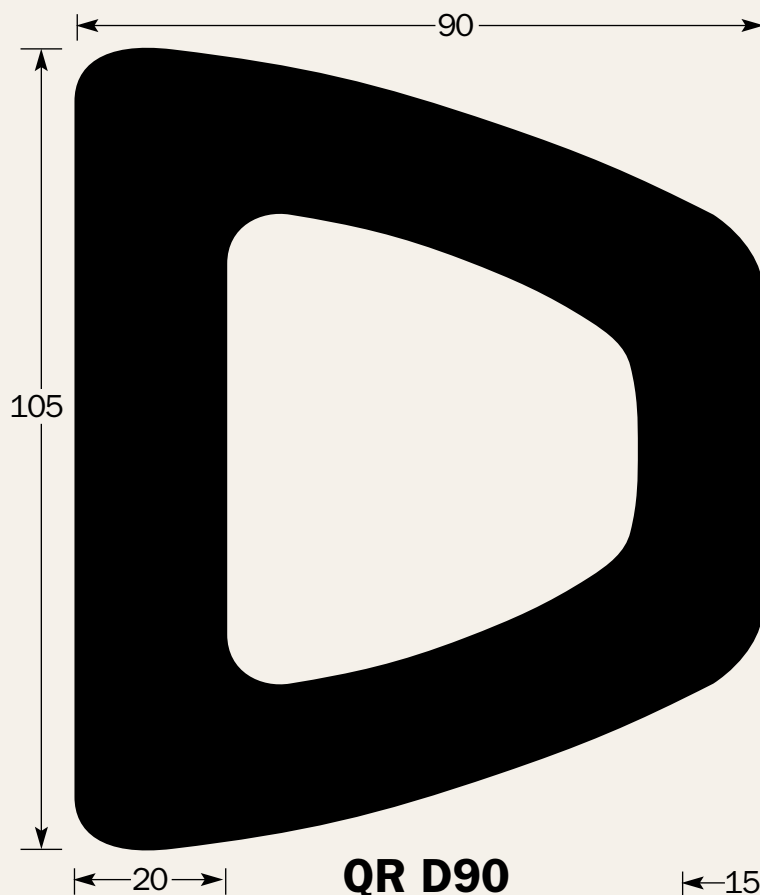

**QR D90**

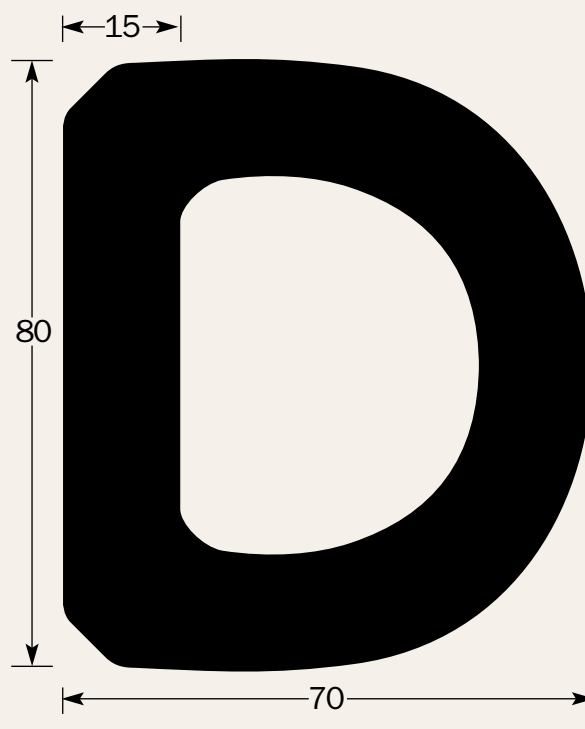

**QR D70**

# Marina Fendering

PROFILES NOT TO SCALE

Colours available: White / Grey / Black  
(All dimensions in mm. Commercial Tolerances apply.)

## QR D110

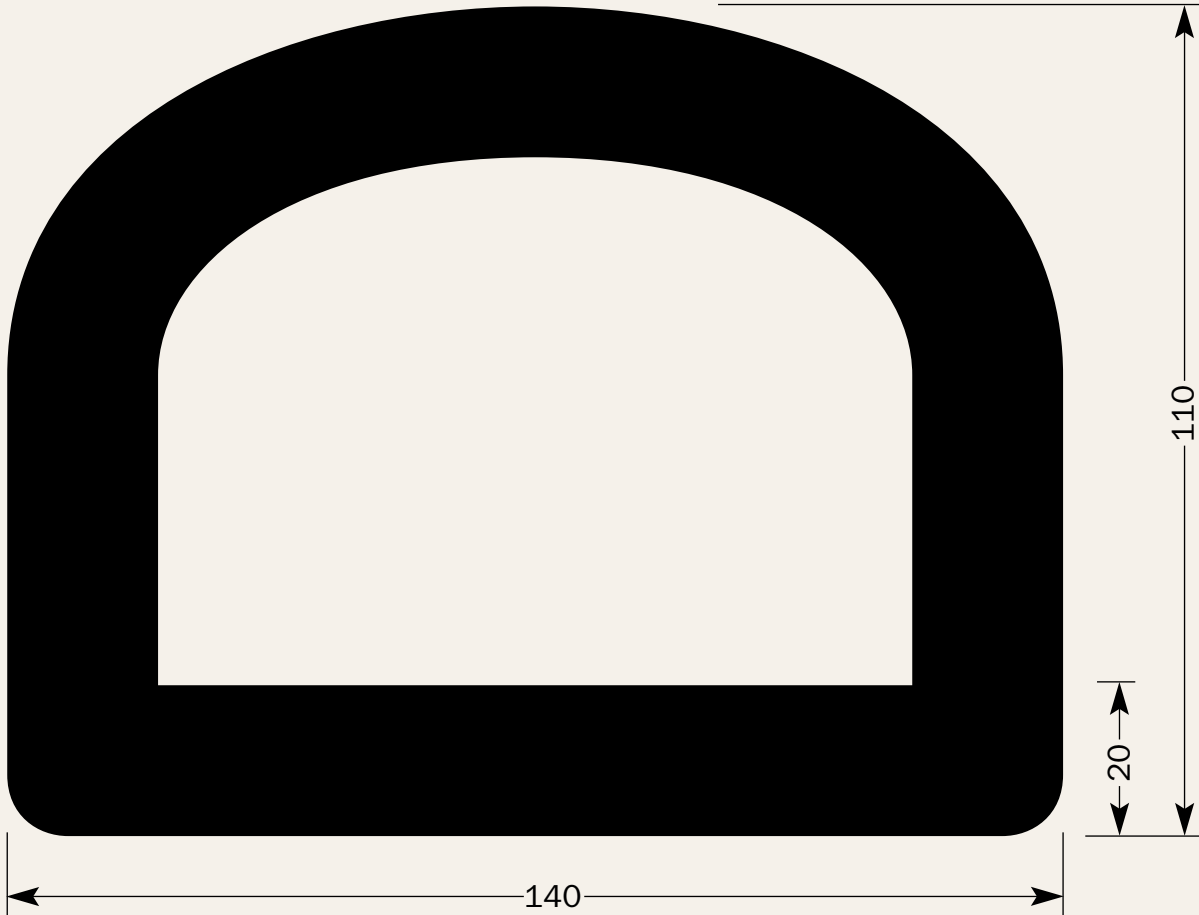

## QR DE50

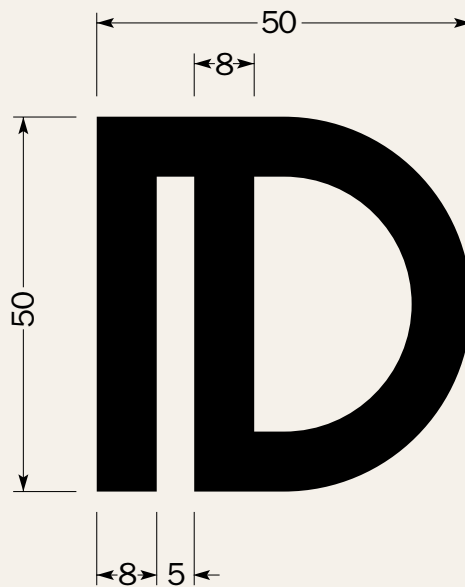

PROFILES NOT  
TO SCALE

# Marina Fendering

Colours available: White / Grey / Black  
(All dimensions in mm. Commercial Tolerances apply.)

## QR D105

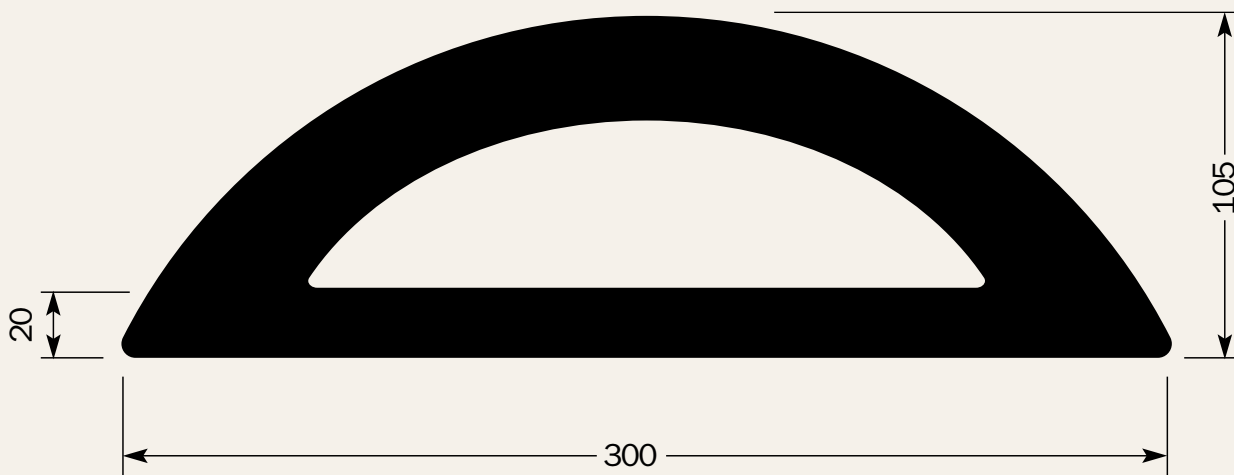

## QR W

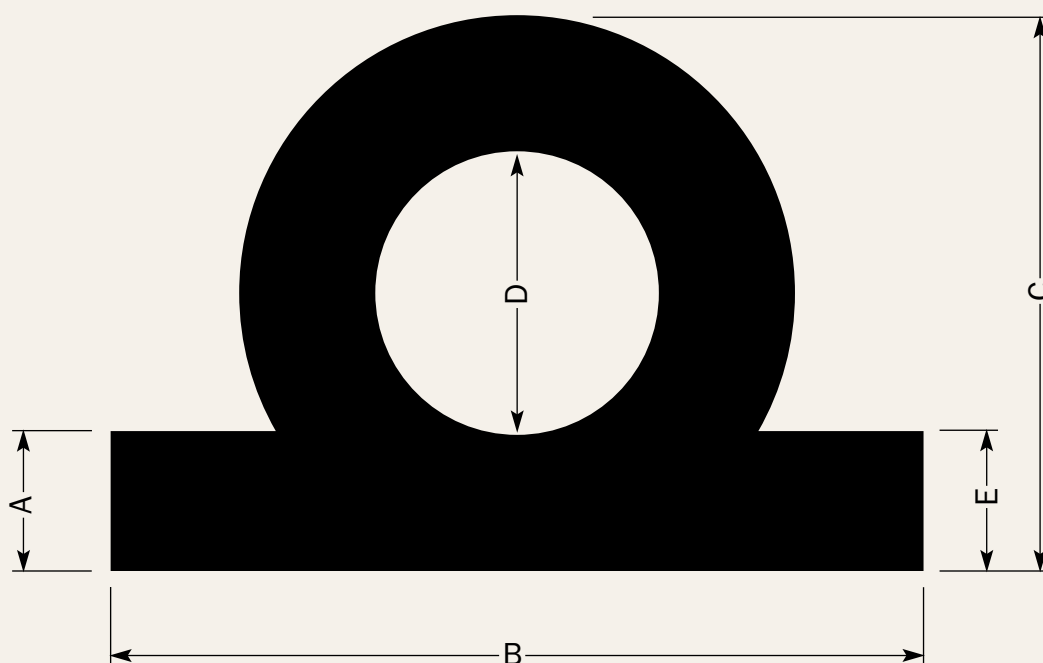

	A	B	C	D	E
QR W124	35	215	124	62	30
QR W147	37	215	147	75	35
QR W150	40	230	150	80	35



PROFILES NOT TO SCALE

# Marina Fendering

Colours available: White / Grey / Black  
(All dimensions in mm. Commercial Tolerances apply.)

QR DS50

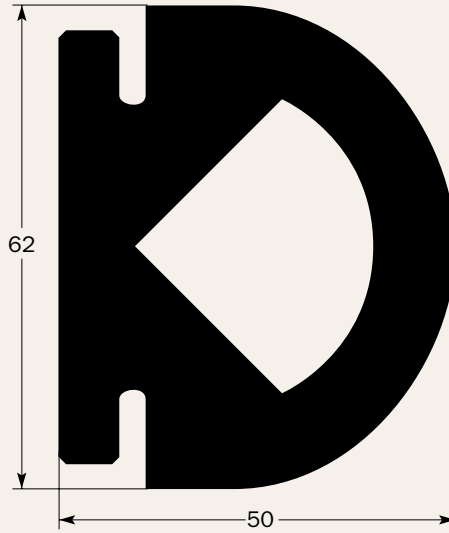
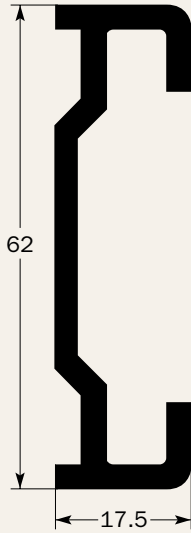

QR DS75

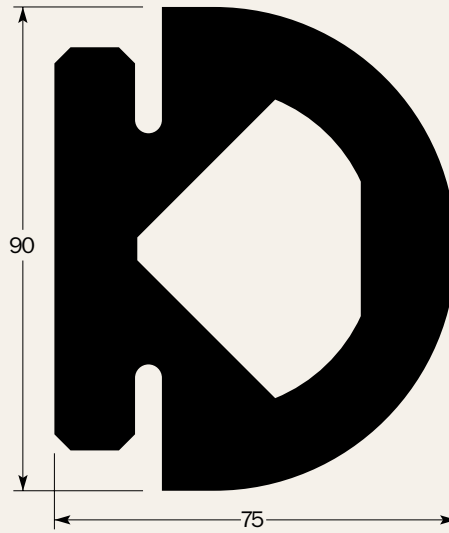
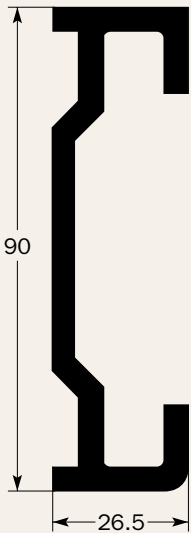

# Square & D Fender

Trelleborg Fenders are able to be delivered with fixing points ie holes drilled into the fender, sloping ends and fixing plates, bolts and accessories. Extruded lengths vary dependent on handling and transport criteria.

Fixing details are specifically designed to accommodate fender size, fender usage and mounting arrangements.

Energy absorption and reaction forces data for our standard fender range are available upon request.

We provide a cost and obligation free service to assist in the design and application of fendering to meet your specific needs.

TYPICAL FENDER ATTACHMENT

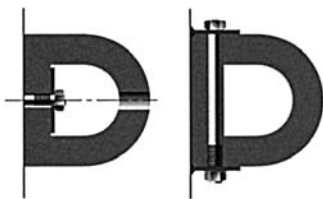

## Recommended Bolt Spacings

A & B	Bolt Size	Bolt Spacing
80	M12	250
100	M12	250
125	M16	300
150	M16	300
200	M20	350
250	M24	400
300	M24	400
350	M30	400
400	M30	400
500	M36	450

## D-FENDER

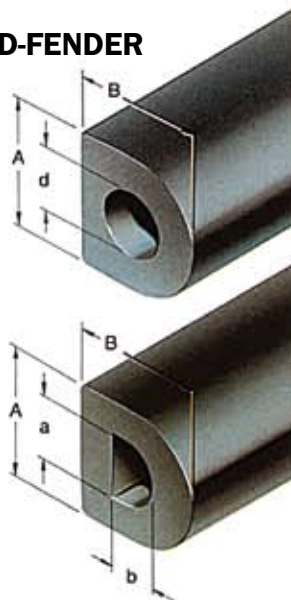

Width A (mm)	Height B (mm)	Hole Diameter d (mm)	Weight (kg/m)
100	100	30	9.6
150	150	65	19.6
200	200	75	36.6
250	250	100	56.6
300	300	125	79.7
350	350	150	107.2
400	400	175	138.9

Width A (mm)	Height B (mm)	Width a (mm)	Height b (mm)	Weight (kg/m)
80	70	45	30	4.5
100	100	50	45	8.1
125	125	60	60	12.5
150	150	75	75	17.0
200	150	100	80	22.0
200	200	100	100	30.0
250	200	125	100	37.0
250	250	125	125	48.2
300	300	150	150	70.5
350	350	175	175	95.9
400	400	200	200	125.3

## SQUARE FENDER

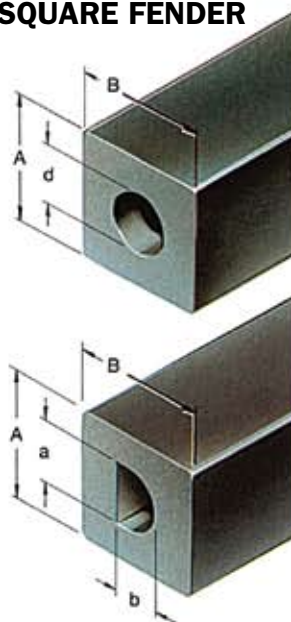

Width A (mm)	Height B (mm)	Hole Diameter d (mm)	Weight (kg/m)
100	100	30	10.8
150	150	65	22.3
165	125	65	20.1
200	200	75	41.3
200	200	100	37.3
250	200	80	52.9
250	250	100	61.5
300	250	100	77.9
300	300	125	93.7
400	400	200	148.6
500	500	250	231.2

Width A (mm)	Height B (mm)	Width a (mm)	Height b (mm)	Weight (kg/m)
100	100	50	45	9.3
150	150	70	65	21.5
165	125	80	60	19.1
200	150	90	65	29.0
200	200	90	95	37.6
250	200	120	95	46.5
250	250	120	120	57.6
300	250	140	115	71.0
300	300	125	135	90.4
400	400	200	200	145.4
500	500	250	250	227.2

## SOLID FENDER

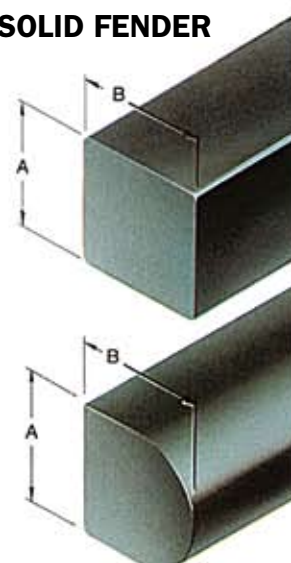

Width A (mm)	Height B (mm)	Weight (kg/m)
100	100	11.7
150	150	26.3
200	200	46.8
250	250	73.1
300	300	105.3
350	350	143.3
400	400	187.2
100	100	10.4
150	150	23.5
200	200	41.8
200	250	53.5
250	250	65.3
300	300	94.0
350	350	127.9
400	400	167.0

# Marina Fendering

PROFILES NOT TO SCALE

Designed for the Marine Environment

PROFILE	W	BOLT SIZE	BOLT CENTRES	BEARING PLATE WIDTH	BEARING PLATE THICKNESS	T
	mm		mm	mm	mm	mm
QR D35	35	M8	300	20	3	8
QR D50	50	M10	300	50	5	10
QR D65	65	M10	300	50	5	20
QR D70	70	M10	300	32	5	15
QR D80	80	M10	300	50	5	15
QR D90	90	M10	300	50	5	20
QR D100	100	M10	300	50	5	20
QR D110	110	M10	300	50	5	20
QR L35	35	M8	300	20	3	10
QR L65	65	M10	300	50	5	20
QR P30	This profile is designed to be nailed (30mm long galvanized siding nails) through both top and bottom 'lips' at approx. 250mm centres.					8
QR P35	35	M6	300	20	3	10
QR P50	50	M8	300	32	5	10

Rubber compound used in the DEEFEND range of extruded fenders has the following specifications:-

- Shore Durometer Hardness (AS 1683.15) 65-80
- Tensile strength (AS 1180.2) 12 MPa (min.)
- Ultimate tensile strain (AS 1683.11) 350% (min.)
- Compression set (AS 1683.138) 35% (max.)
- Tear resistance (AS 1683.12) 50kN/m (min.)

The fendering material is extruded natural rubber, compounded to be highly resistant against attack by sea-water, oxygen, ozone and ultraviolet light encountered in the marine environment.

Natural rubber is inherently more resilient than other elastometric and plastic materials, and is ideal in absorbing berthing energy and protecting both the marina and vessel.

Standard colours are white, grey and black. Other colours are available on special order.

\* Complete fendering system including moulded corner section and end caps is available for these profiles.

## Fixing Details Deefend Marina Fenders

Illustrations of 'D' & 'L' profiles installed

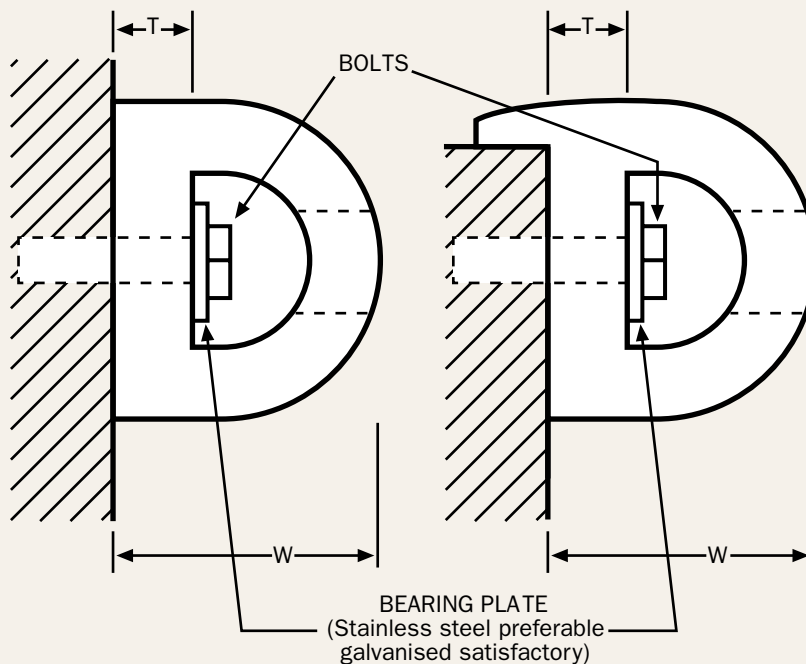

# Ladder Fenders

In the harsh marine environment, steel and timber ladders not only deteriorate, but are also subject to severe damage and permanent deformation, due to collision with ships and tugs.

To alleviate these problems, the ladder system is manufactured from rubber, which resists permanent deformation and provides protection to both the wharf and the ship.

Trelleborg rubber ladders are available in the following configurations:

## Trelleborg LFE Model

The LFE ladder fender can be supplied as two separate sections:

- Section mounted on wharf face
- Suspended section

The vertical sides of the ladder are designed to deform under vessel impact, providing energy absorption and returning to the undeformed state after impact. The rungs are rubber enclosed chain, ensuring both flexibility and strength.

The suspended section is polyurethane enclosed chain to provide flexibility with rubber enclosed solid rungs to enhance ease of climbing.

Fittings can be provided in either galvanised steel or 316L stainless steel to meet local requirements.

The vertical side rungs are supplied in a safety yellow to increase visibility.

Other colours are also available.

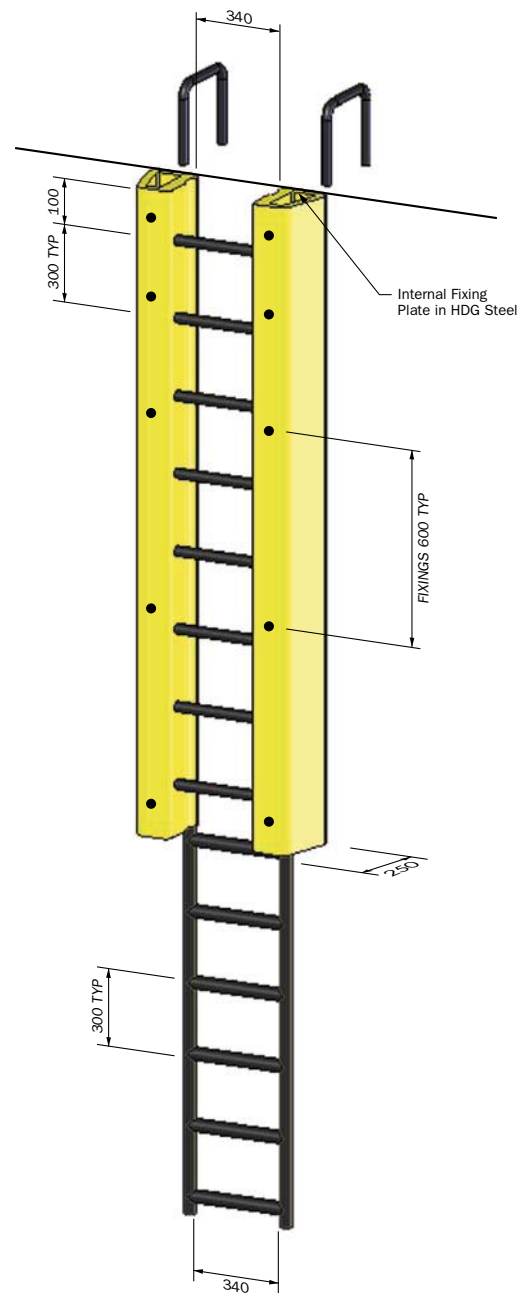

Performance characteristics per metre of both pillars.

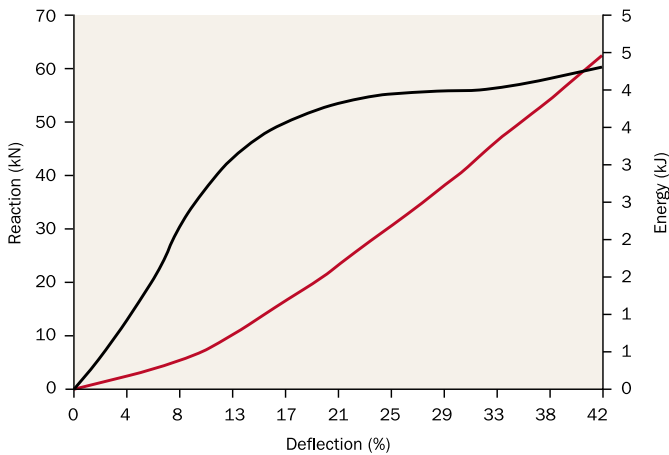

Length (mm)	Weight (kg)	No. of rungs	Mounting Bolts M20
1600	120	5	2x4
1900	143	6	2x4
2100	158	7	2x4
2400	180	8	2x5
2700	202	9	2x5
3000	225	10	2x6
3300	250	11	2x6
3600	270	12	2x7
3800	285	13	2x7
4000	300	14	2x8

# Ladder Fenders

## Trelleborg LFP Model

The LFP ladder is a modification of the arch ladder. Rungs can be provided in galvanised steel or 316L SS. The top of the fender is fitted with a U.H.M.W- polyethelene pad to provide a low friction contact surface for a vessel.

The LFP ladder fender is most suitable for large vessel berths and where the mounting width is restricted.

Performance characteristics per metre of both pillars.

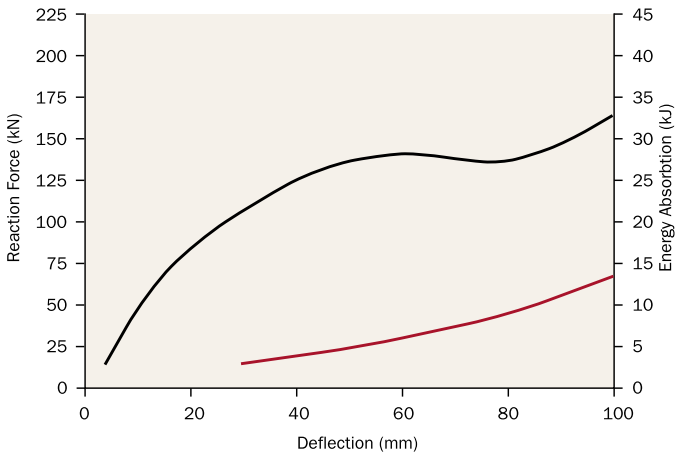

Length (mm)	Weight (kg)	No. of rungs	Mounting Bolts M20
1520	81	4	2x3
2020	107	5	2x4
2520	133	7	2x5
3020	160	8	2x6

Units are able to be combined to make longer lengths.

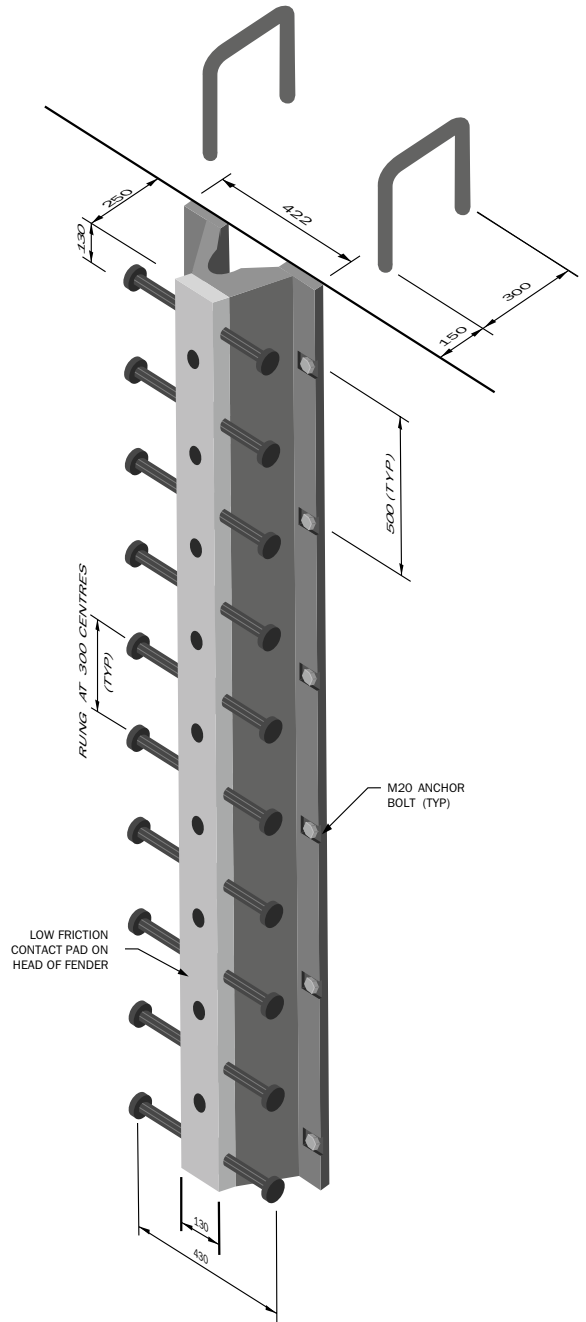

# Replacement Units for Older Generation Fenders

Trelleborg produces replacement systems for many fender manufacturers whose products have been relegated to the pages of history. The manufacturers and models shown below are some of the replacement units available:



Leg Fender  
Morse & Lord

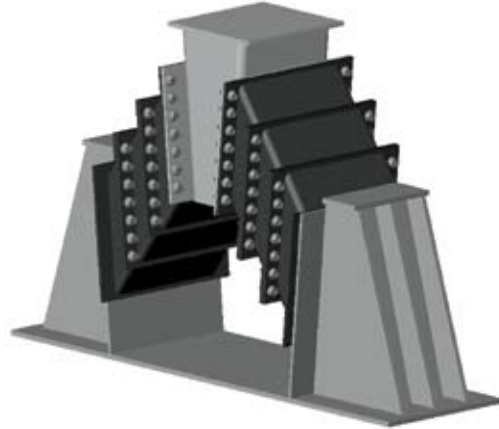

Raykin Fender

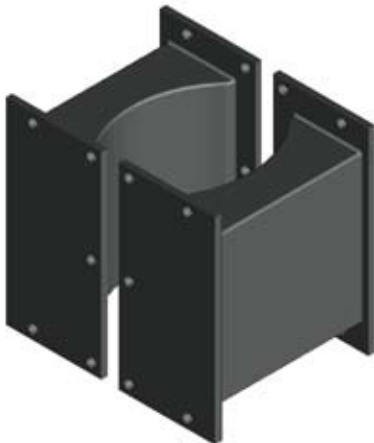

Seibu "H" Type



Seibu "TTV" Type



Shear Fender  
Morse

# Marina Fender Bars

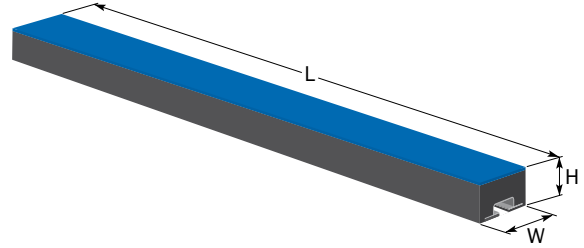
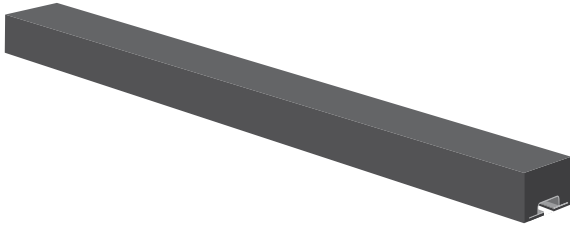

Fender bars are resistant to high impact and are suitable for a wide range of applications, including fender piles, sheet-pile or concrete quays, ferry ramps and bumper guards on boats and barges.

The heavy-duty mounting system is designed for fast, simple installation and is embedded in the rubber in order to eliminate corrosion.

T-bolts can be supplied.

The low profile of the aluminium mounting ensures maximum utilization of the rubber's elasticity. Fender bars can be bolted to U-section beams which can then be welded in place.

Customised fender bars with a layer of low-friction UHMW-PE bonded integrally to the face are also available in 50 or 75 high x 100mm x 1500mm.

Fender Type (LxWxH)	Available
1500mm x 100mm x 100mm	Rubber and PE
1500mm x 100mm x 75mm	Rubber and PE
1500mm x 100mm x 50mm	Rubber and PE
2000mm x 150mm x 125mm	Rubber Only

# Marina Protection Plates

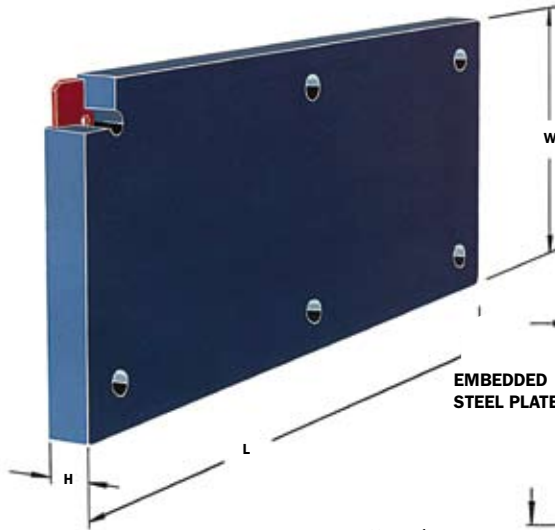

- Plate thickness can vary upon specifications.
- Holes are drilled to customer's specifications upon request.
- Available in mild & stainless steel plates.
- Standard colours available include: Black, Yellow, Blue and Grey.
- Other colours available as optional extra (non-marking material).

For anchor  
M 20 (3/4")

Number of anchors:  
L=1000 4pcs  
L=1800 6 pcs

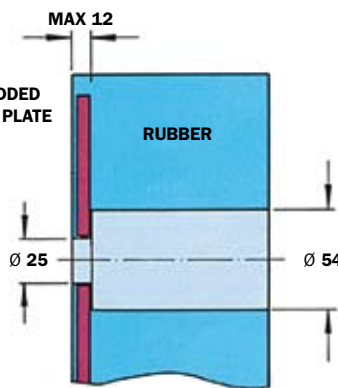

Length	Width	Thickness
1200mm	1100mm	35mm
1200mm	1100mm	50mm
1200mm	1100mm	70mm
1200mm	1100mm	80mm
1500mm	1200mm	50mm
1500mm	1200mm	60mm
1500mm	1200mm	80mm
1500mm	1200mm	100mm
1850mm	1350mm	50mm
1850mm	1350mm	60mm

Trelleborg marina protection plates (MPP) are resilient bumpers designed for quays where small vessels such as fishing boats or pleasure craft are moored.

They are also appropriate where the distance between the vessel and the quay has to be minimised.

The design includes a heavy-duty steel backplate which is moulded integrally into the rubber, so that only a few bolts are needed for mounting.

# Ultra High Molecular Weight Polyethylene Sliding Fenders

Cross section tolerance  $\pm 4\%$  Length tolerance  $\pm 10\text{mm}$

Thickness Available	Max Length Bolt Diam	Recommended Drillings (max)	Distance Between
30mm	5 metres	12mm	500mm
40mm	5 metres	16mm	500mm
50mm	5 metres	16mm	500mm

Note: Standard colour Black. Other colours on request. All orders cut to size.

## Material Specifications: UHMWPE Sliding Fender

Property	Testing Standard	Unit	Value
Specific Gravity	DIN 52479	$\text{g/cm}^3$	= 0.5
Tensile Strength	DIN 53455	$\text{N/mm}^2$	> 19
Molecular Weight	Light Diffusion Method		= 200 000 > 3.3m
Notched Impact Stength (Notch Value)	DIN 53453	$\text{mJ/mm}^2$	approx. 130
Ball Indentification Hardness	DIN 53456	$\text{N/mm}^2$	$\geq 30$
Coefficiant of Friction (PE/steel)	DIN 53375		0.1 - 0.15
Elongation at tear	DIN 53455	%	> 400
Temperature Range		$^{\circ}\text{C}$	$-40^{\circ}\text{C}$ up to $+90^{\circ}\text{C}$
Shore Hardness	DIN 53505	Shore D	65

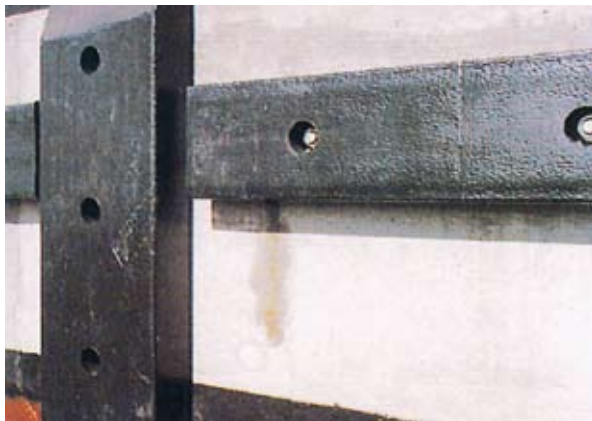

### Brisbane

Phone +61 (7) 3866 7444  
 Facsimile + 61 (7) 3263 4912  
 Email: [tqr.info@trelleborg.com](mailto:tqr.info@trelleborg.com)  
[www.trelleborg.com.au](http://www.trelleborg.com.au)

### Perth

Phone +61 (8) 9256 6000  
 Facsimile + 61 (8) 9353 5990  
 Email: [admin.perth@trelleborg.com.au](mailto:admin.perth@trelleborg.com.au)  
[www.trelleborg.com.au](http://www.trelleborg.com.au)